

Malaga-B/1/170/20

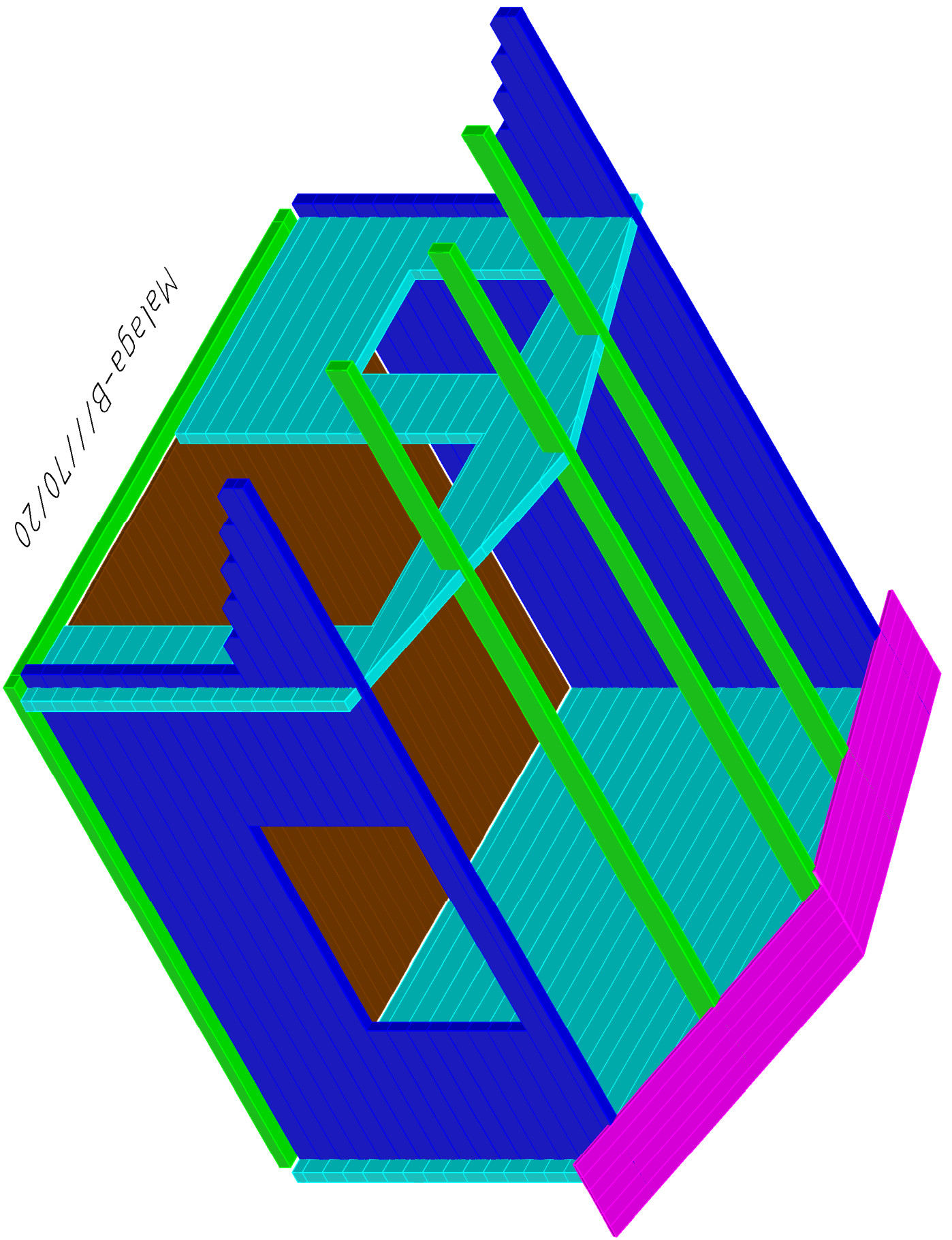

# Malaga-B///70/20

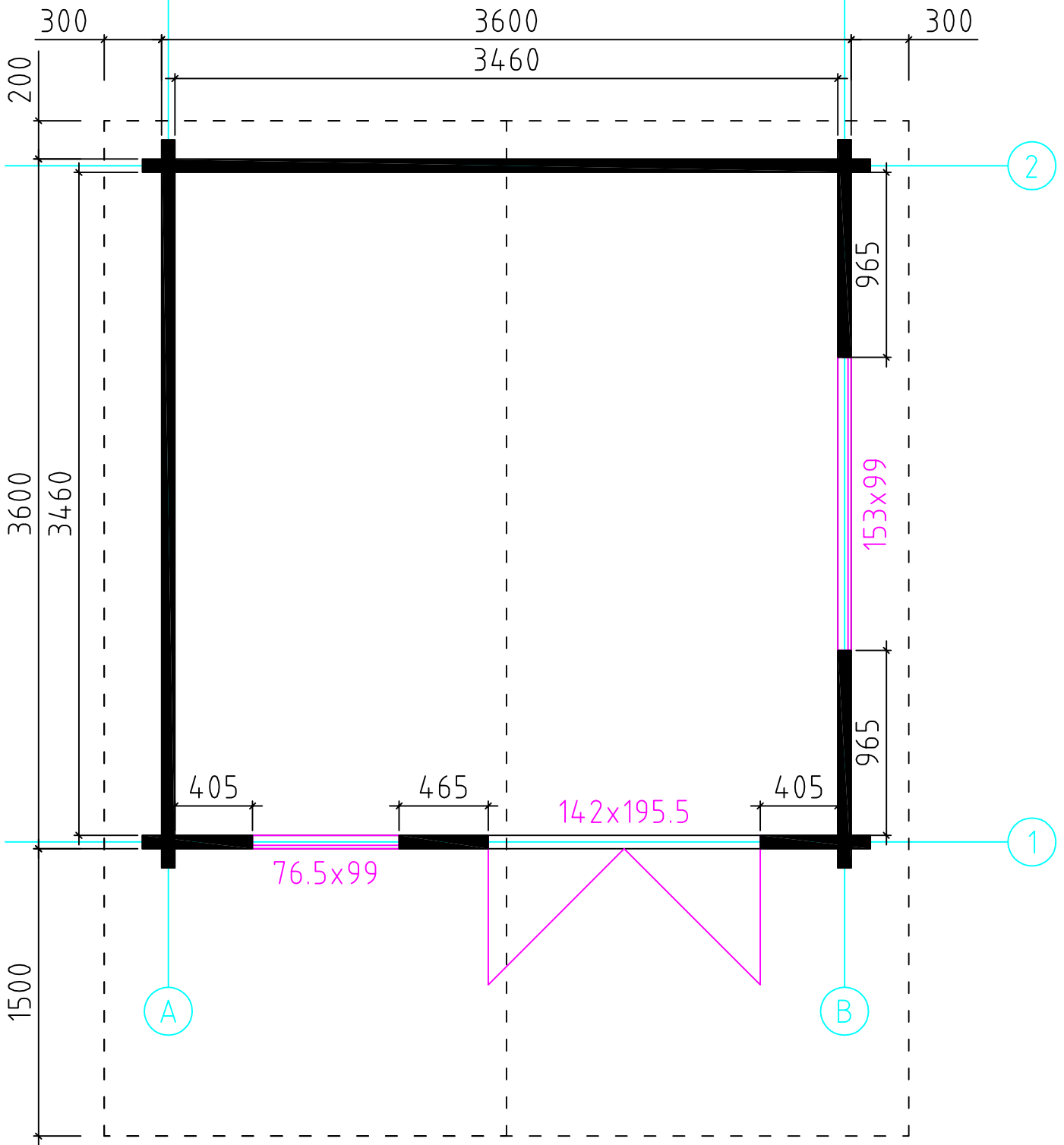

Grundplan

# Malaga-B///70/20

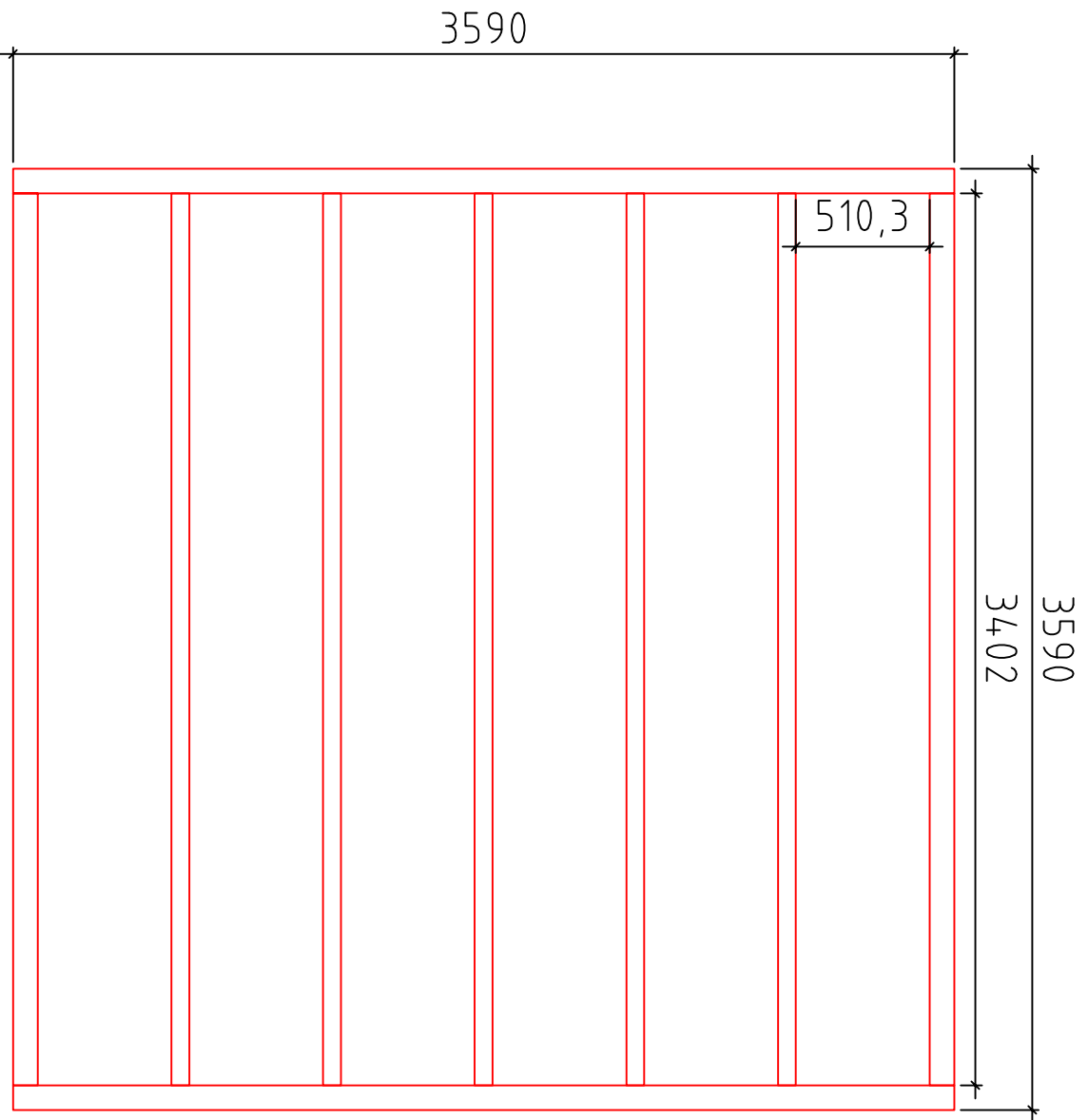

Fundament

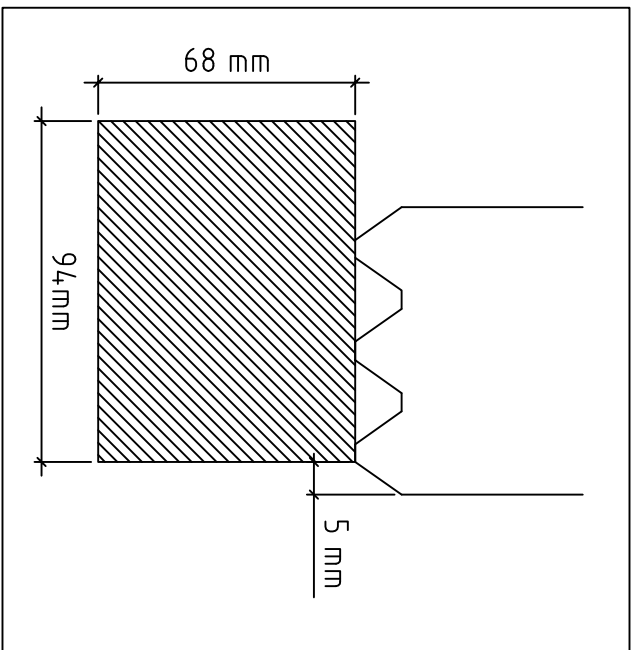

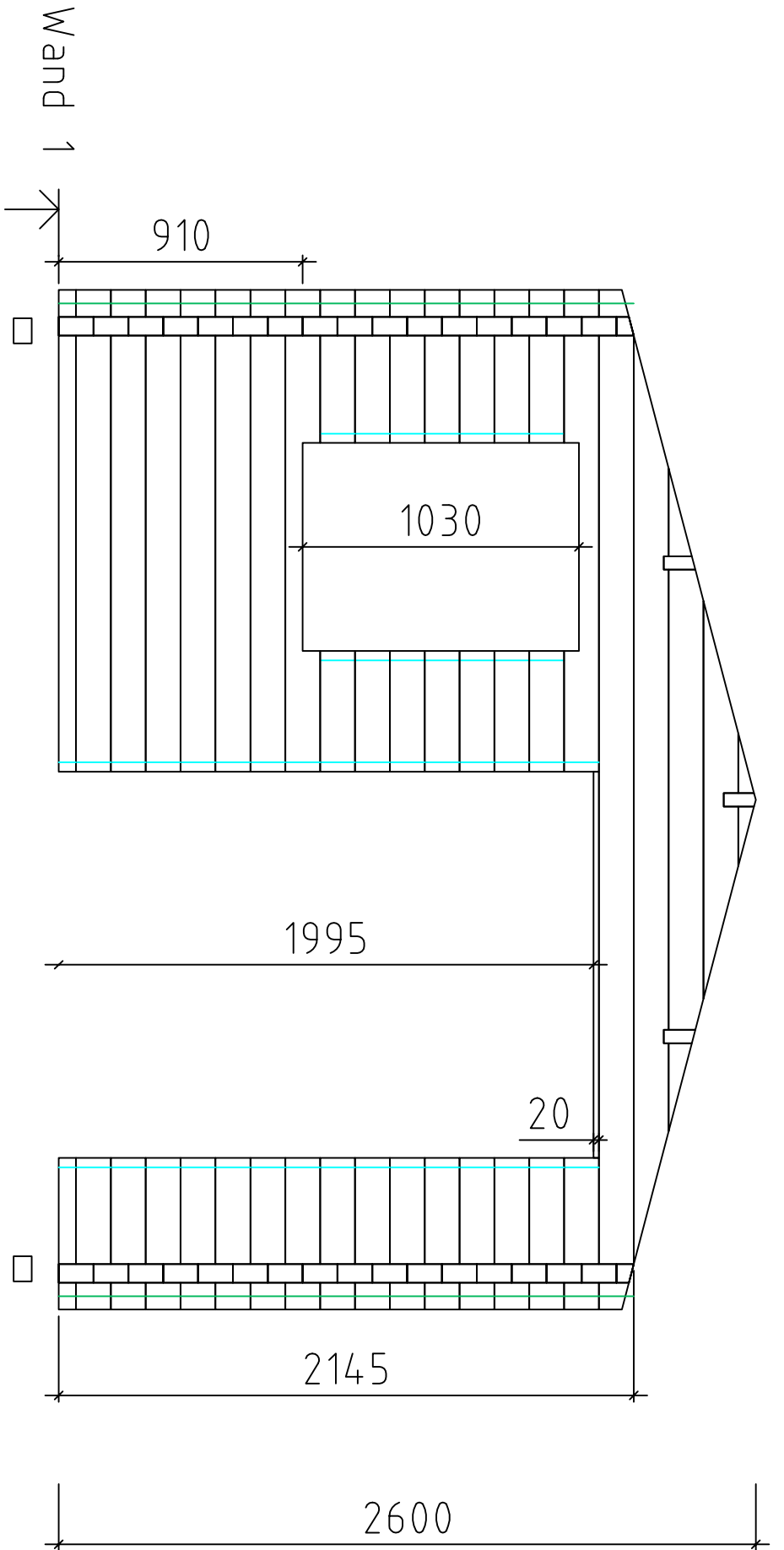

100 70  
 400  
 775  
 450  
 1440  
 395  
 70 100

A

B

3530

3800

Malaga-B///70/20

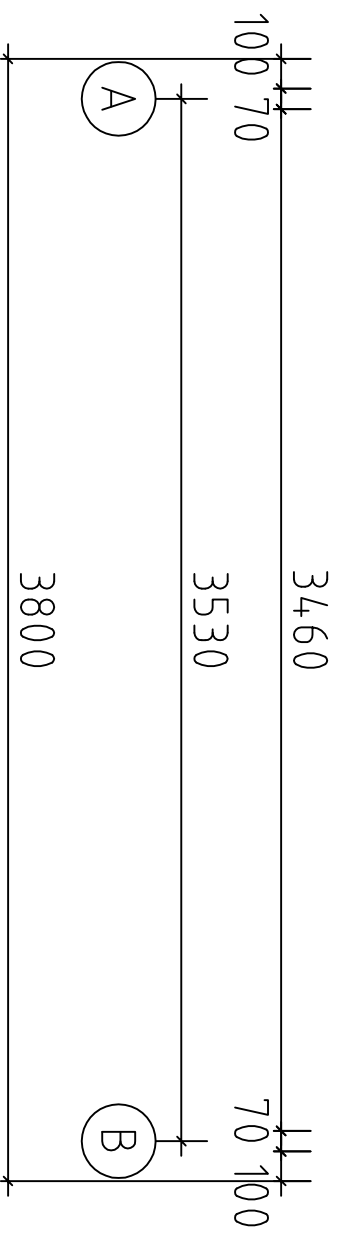
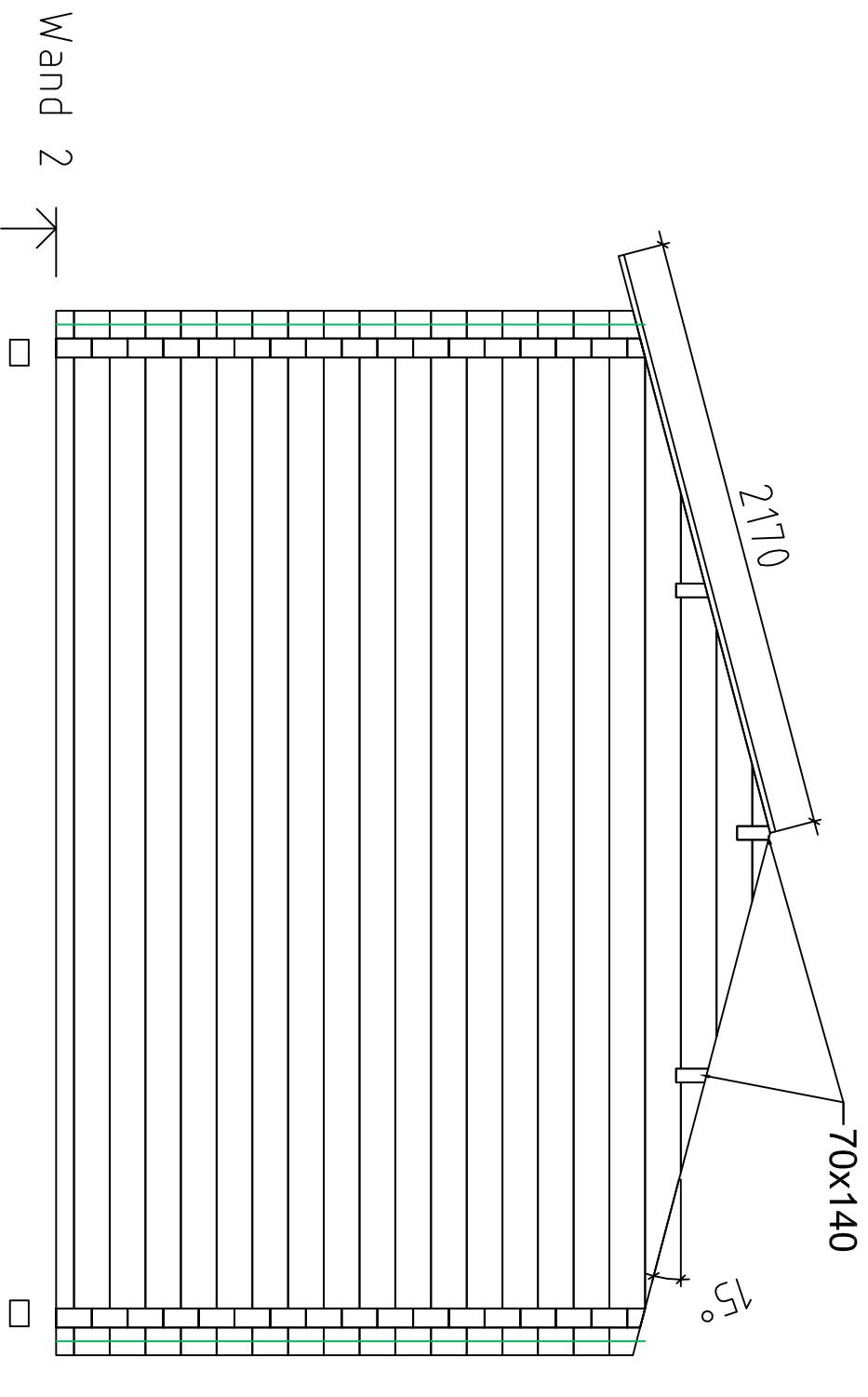

Malaga-B///70/20

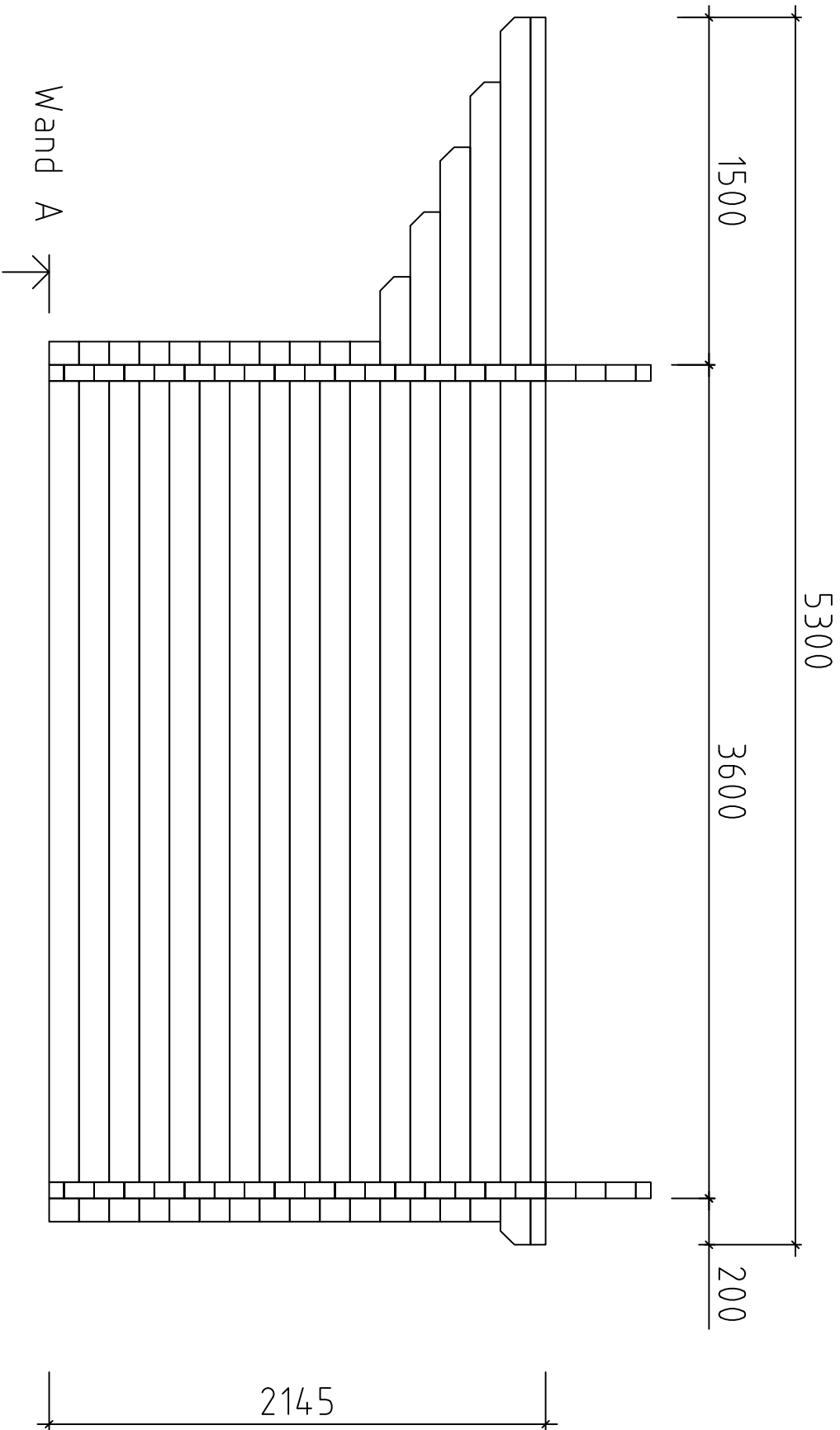

Malaga-B///70/20

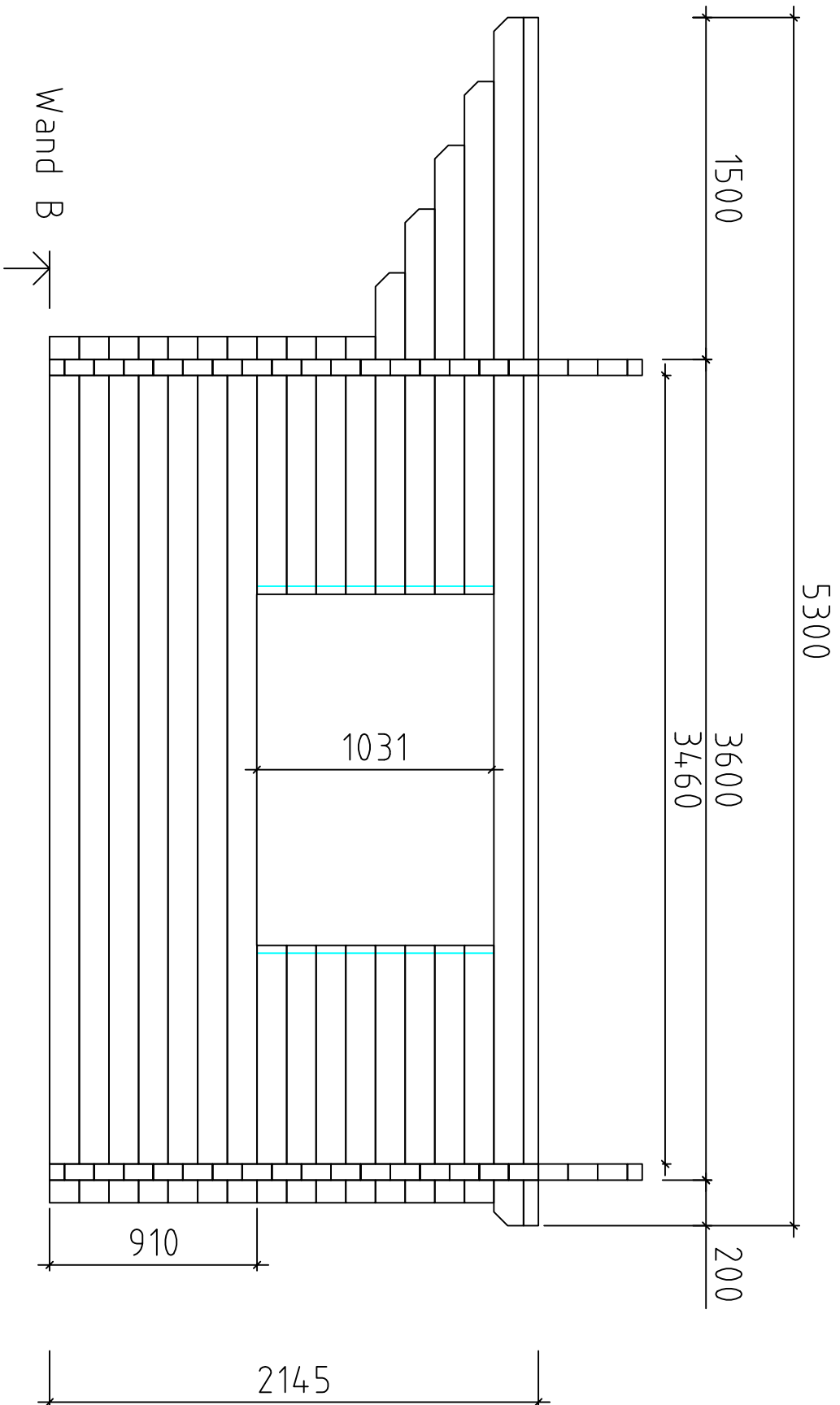

Malaga-B///70/20

BC

Fenster 1530x990 (Lengi mōōt!i)

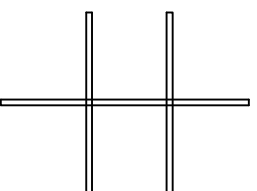
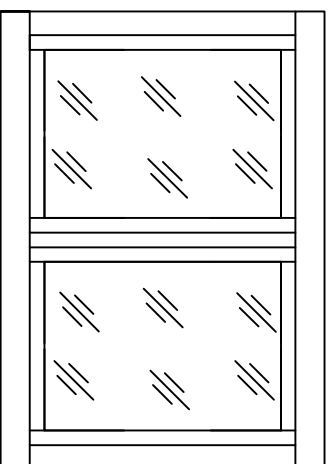
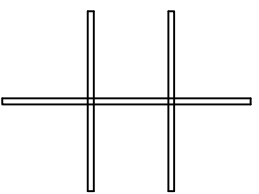

AB

Tür 1420x1955 (Lengi mōōt!i)

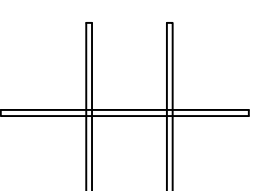
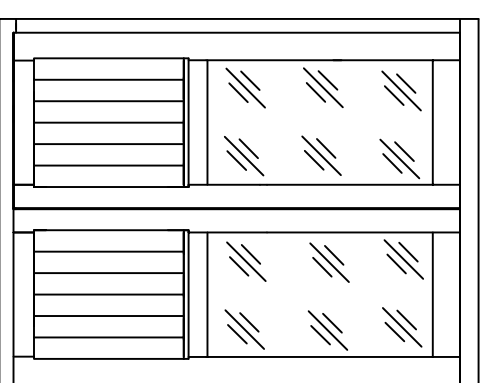
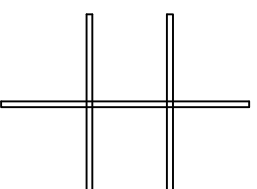

BC

Fenster 765x990 (Lengi mōōt)

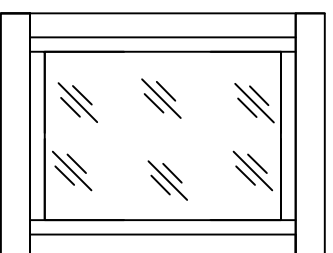
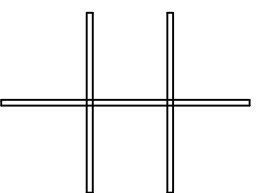

Malaga-B//170/20